

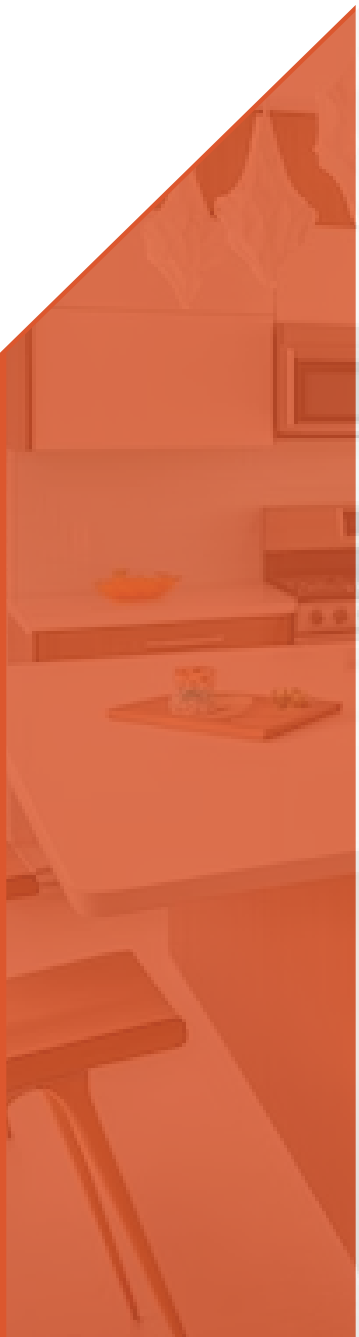

iman
M O B I L I A R I O

Barrales y tiradores.



TU
ELECCIÓN

Accioná tu espacio de
la manera que quieras.

Barral de acero

De Ø10 y Ø14mm.
 Acero cromado mate.
 Rosca métrica 4.
 Incluye tornillos de fijación.
Material: acero cromado mate.

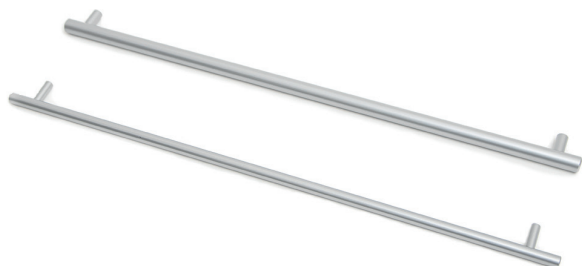

Manija barral Ø10 con soportes de Ø8					
Código EH	A	B	C	Soportes	Empaque
EHACM-064104	64	104	32	2	10/100
EHACM-096136	96	136	32	2	10/100
EHACM-128168	128	168	32	2	10/100
EHACM-160200	160	200	32	2	10/100
EHACM-192232	192	232	32	2	10/50
EHACM-288328	288	328	32	2	10/50
EHACM-352392	352	392	32	2	10/50
EHACM-448498	448	488	32	3	10/50
EHACM-736786	736	776	32	3	10/20

Manija barral Ø14 con soportes de Ø10					
Código EH	A	B	C	Soportes	Empaque
EHACM14-192232	192	232	32	2	10/50
EHACM14-228328	228	268	32	2	10/40
EHACM14-352392	352	392	32	2	10/30
EHACM14-448488	448	488	32	3	10/20
EHACM14-736776	736	776	32	3	10
EHACM14-9601000	960	1000	32	3	10
EHACM14-10561096	1056	1096	32	3	10
EHACM14-12161256	1216	1256	32	3	10

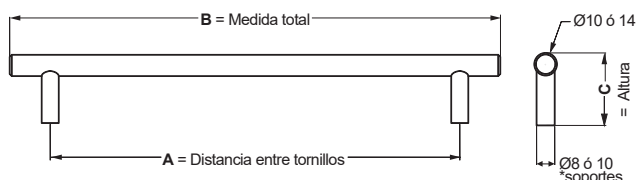

Tirador de aluminio 001

Rosca 5/32".
 Incluye tornillos de fijación.
Material: aluminio anodizado mate.

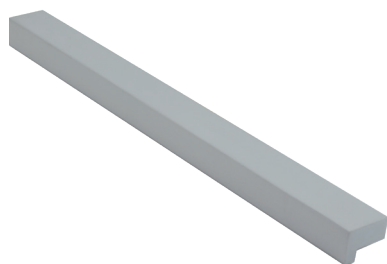

Código EH	A	B	C	Empaque
EH001-0032A	32	64	17	50/200
EH001-0064A	64	96	17	50/200
EH001-0096A	96	128	17	50/200
EH001-0128A	128	160	17	50/200
EH001-0160A	160	192	17	60/240
EH001-0192A	192	224	17	50/200
EH001-0288A	288	322	17	50/200

Tirador de aluminio 002

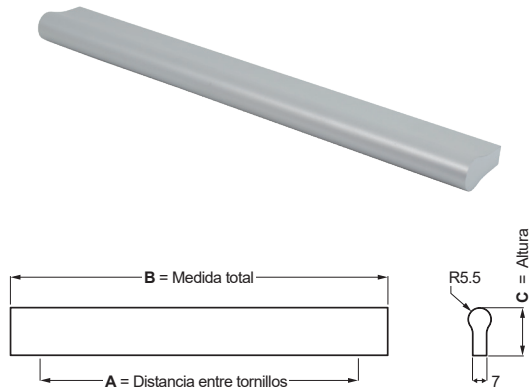

Rosca 5/32".
Incluye tornillos de fijación.
Material: aluminio anodizado mate.

Código EH	A	B	C	Empaque
EH002-0032A	32	64	24	50/200
EH002-0064A	64	96	24	50/200
EH002-0096A	96	128	24	50/200
EH002-0128A	128	160	24	50/200
EH002-0160A	160	192	24	60/240
EH002-0192A	192	224	24	50/200
EH002-0288A	288	322	24	40/160

Tirador de aluminio 003

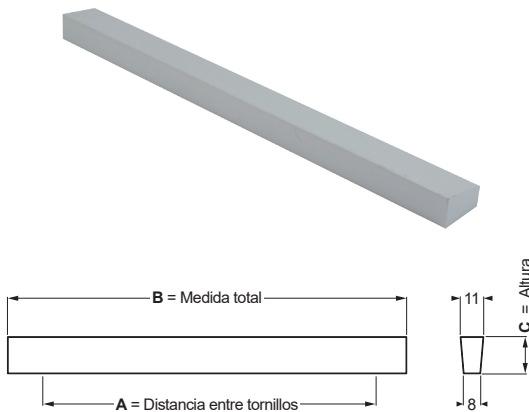

Rosca 5/32".
Incluye tornillos de fijación.
Material: aluminio anodizado mate.

Código EH	A	B	C	Empaque
EH003-0032A	32	64	17,5	50/200
EH003-0064A	64	96	17,5	50/200
EH003-0096A	96	128	17,5	50/200
EH003-0128A	128	160	17,5	50/200
EH002-0160A	160	192	17,5	60/240
EH003-0192A	192	224	17,5	50/200
EH003-0288A	288	322	17,5	50/200

Tirador de aluminio 004

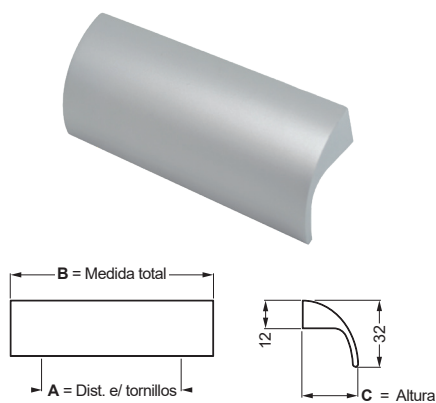

Rosca 5/32".
Incluye tornillos de fijación.
Material: aluminio anodizado mate.

Código EH	A	B	C	Empaque
EH004-0032A	32	64	26	50/200
EH004-0064A	64	96	26	50/200
EH004-0128A	128	160	26	75/300

Tirador de aluminio 005

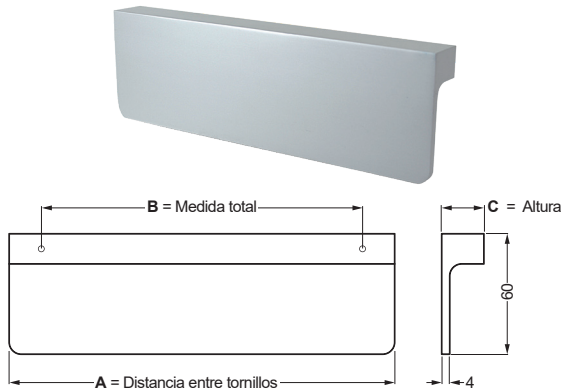

Rosca 5/32".
Incluye tornillos de fijación.
Material: aluminio anodizado mate.

Código EH	A	B	C	Empaque
EH005-0064A	64	96	21	50/200
EH005-0128A	128	160	21	30/120
EH005-0160A	160	192	21	25/100

Tirador de aluminio 006

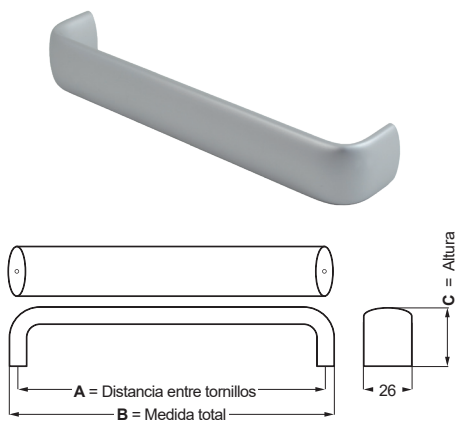

Rosca 5/32".
Incluye tornillos de fijación.
Material: aluminio anodizado mate.

Código EH	A	B	C	Empaque
EH006-0128A	128	138	31	50/200
EH006-0160A	160	170	31	50/200
EH006-0192A	192	202	31	50/200
EH006-0256A	256	266	31	40/160
EH006-0320A	320	330	31	30/120

Tirador de aluminio 007

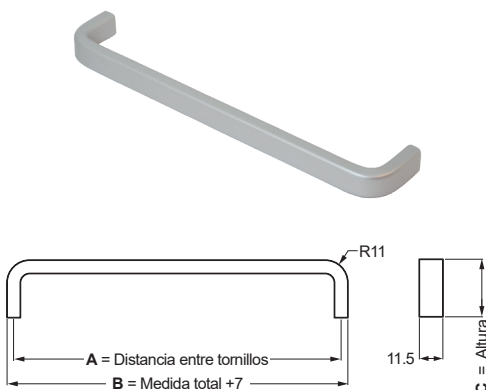

Rosca 5/32".
Incluye tornillos de fijación.
Material: aluminio anodizado mate.

Código EH	A	B	C	Empaque
EH007-0128A	128	135	28	75/300
EH007-0160A	160	167	28	75/300
EH007-0192A	192	199	28	50/200
EH007-0256A	256	263	28	50/200

Tirador de aluminio 008

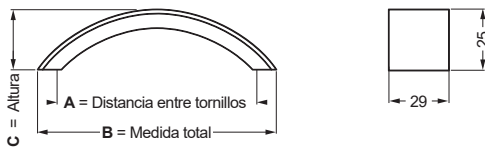

Rosca 5/32".
Incluye tornillos de fijación.
Material: aluminio anodizado mate.

Código EH	A	B	C	Empaque
EH008-0096A	96	116	30	50/200
EH008-0128A	128	148	30	50/200
EH008-0160A	160	180	30	50/200

Tirador de aluminio 009

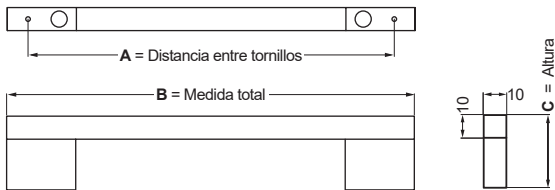
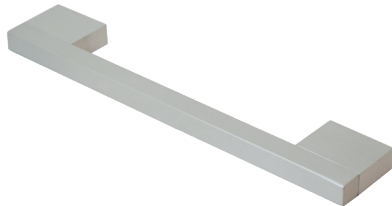

Rosca 5/32".
Incluye tornillos de fijación.
Material: aluminio anodizado mate.

Código EH	A	B	C	Empaque
EH009-0160A	160	180	32	50/200
EH009-0224A	224	244	32	50/200
EH009-0320A	320	340	32	50/200

Tirador de aluminio 010

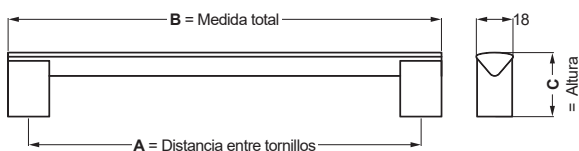
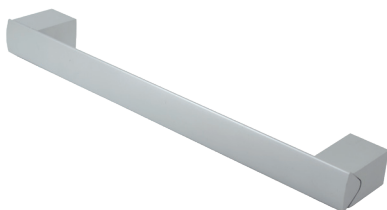

Rosca 5/32".
Incluye tornillos de fijación.
Material: aluminio anodizado mate.

Código EH	A	B	C	Empaque
EH010-0160A	160	180	31	50/200
EH010-0192A	192	212	31	50/200
EH010-0224A	224	244	31	50/200

Medidas indicadas sin compromiso. Nos reservamos el derecho de realizar modificaciones, consulte en nuestra web la última versión actualizada del mismo.

Tirador de aluminio O11

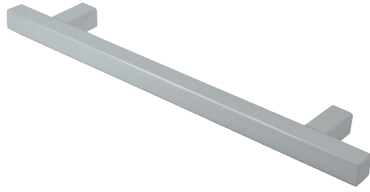

Rosca 5/32".
Incluye tornillos de fijación.
Material: aluminio anodizado mate.

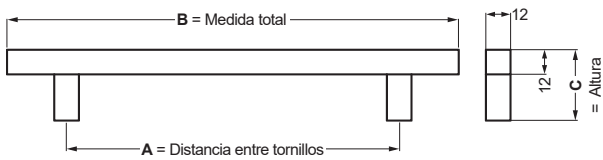

Código EH	A	B	C	Empaque
EH011-0096A	96	156	34,5	50/200
EH011-0160A	160	220	34,5	50/200
EH011-0224A	224	284	34,5	50/200
EH011-0320A	320	380	34,5	25/100

Perfil manija oculto superior

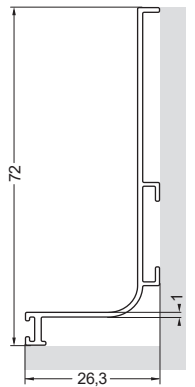
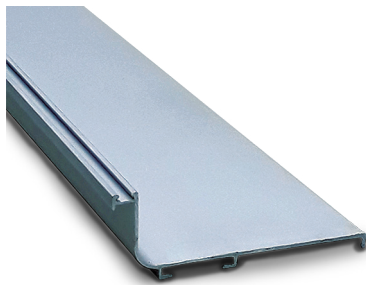

Código EH	Descripción	Color	Empaque
EHPAMOSX5	Perfil manija oculto superior	Aluminio anodizado	5 tiras
EHPAMOSXN5	Perfil manija oculto superior	Negro	5 tiras
EHPAMOSXB5	Perfil manija oculto superior	Blanco	5 tiras
EHFCH3M	Felpa, 3 mts	Gris	50 tiras

Largo: 3m.
Film autoadhesivo protector individual.
Material: Aluminio anodizado de 10 micrones.

Perfil manija oculto medio

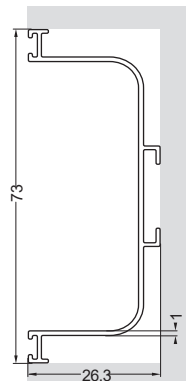
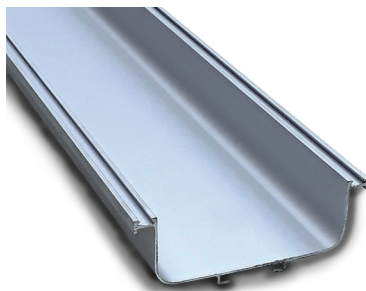

Código EH	Descripción	Color	Empaque
EHPAMOMX5	Perfil manija oculto medio	Aluminio anodizado	5 tiras
EHPAMOMXN5	Perfil manija oculto medio	Negro	5 tiras
EHPAMOMXB5	Perfil manija oculto medio	Blanco	5 tiras
EHFCH3M	Felpa gris, 3 mts	Gris	50 tiras

Largo: 3m.
Film autoadhesivo protector individual.
Material: Aluminio anodizado de 10 micrones.

Perfil manija C

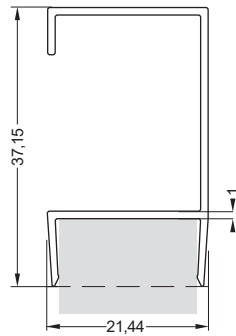
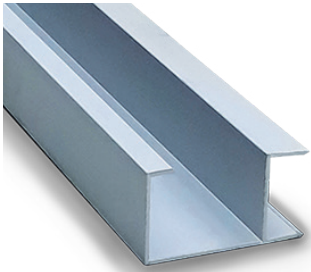

Para placas de 18mm.
 Largo: 3m.
 Film autoadhesivo protector individual.
Material: Aluminio anodizado de 10 micrones.

Código EH	Descripción	Empaque
EHPAC18X6	Perfil manija C	6 tiras

Perfil manija H

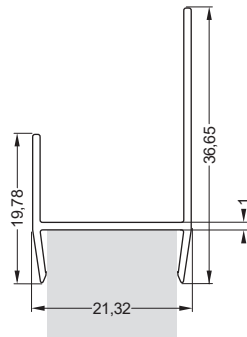
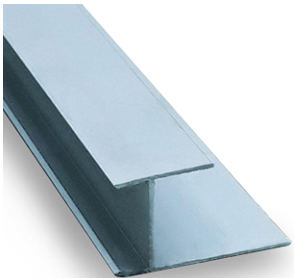

Para placas de 18mm.
 Largo: 3m.
 Film autoadhesivo protector individual.
Material: Aluminio anodizado de 10 micrones.

Código EH	Descripción	Empaque
EHPAH18X6	Perfil manija H	6 tiras

Perfil manija J

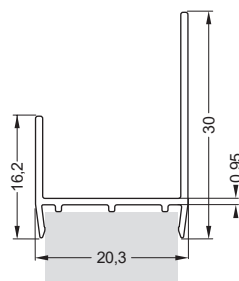
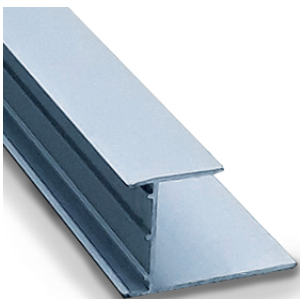

Para placas de 18mm.
 Largo: 3m.
 Film autoadhesivo protector individual.
Material: Aluminio anodizado de 10 micrones.

Código EH	Descripción	Empaque
EHPAJ18X10	Perfil manija J	10 tiras

Medidas indicadas sin compromiso. Nos reservamos el derecho de realizar modificaciones, consulte en nuestra web la última versión actualizada del mismo.